

# FL & FLG Flange Mount Series Mixers

## OWNERSMANUAL

### Warranty

Our products are guaranteed against defective materials and workmanship, we will repair or replace such items as may prove defective at our option. Warranty period is one year on items manufactured by INDCO, except for the MixMaster Series Shakers which carries a two year warranty. On items not manufactured by INDCO, the manufactures warranty applies. All component parts of our products are covered by this warranty, except for normal wear items such as belts or impellers. We cannot be responsible for damage or abuse to equipment caused by improper installation or operation. Warranties can also be voided by unauthorized disassembly of equipment. For warranty repairs, equipment is returned to INDCO at the customer's expense; we will repair and return to customer at our expense. Under no circumstances will we allow labor charges or other expense to repair defective merchandise. This warranty is exclusive and is in lieu of all other warranties, whether express or implied. INDCO shall not be liable for any other damages, whether consequential, indirect, or incidental, arising from the sale or use of its products.



## FL & FLG Series Mixers

### TABLE OF CONTENTS:

Safety & General .....	2
Operation.....	3
Maintenance.....	3
Parts List .....	4

4040 Earnings Way • New Albany, IN 47150  
P: 812-941-5954 F: 812-944-9742  
INDCO.COM • INFO@INDCO.COM

## Safety

Please follow the below safety precautions. If there are any questions, please call INDCO at 800-942-4383. Please read this complete manual before trying to operate your mixer. Failure to follow these instructions could result in serious bodily injury or death.

- Do not touch moving parts while mixer is operating. Do not wear loose-fitting clothes or jewelry around an operating mixer. Keep all hands, feet, clothes, neckties, necklaces and other objects clear of moving parts.
- Never move the unit without a suitable lifting device.
- Have a qualified individual bring power to your unit.
- Always ground the unit. Never use an extension cord.
- Never run the unit in open air.
- Never adjust the speed without the unit running.
- Always lockout the power when working on the unit.

### Electric Motor Safety:

Motors should be installed, protected and fused in accordance with latest issue of National Electrical Code, NEMA Standard Publication No. MG 2 and local codes. Frames and accessories of motors should be grounded in accordance with National Electrical Code (NEC) Article 430. For general information on grounding refer to NEC Article 250.

Not all rotating parts are guarded. Keep hands and clothing away from moving parts.

Trained, qualified personnel should make electrical repairs and non-standard connections.

If environment has hazardous combustible fumes present, use only explosion-proof electric motors.

### Air Motor Safety:

The air motor is designed to be driven by compressed air and under no circumstances be driven with any other gases. Fluids, particles, solids or any substance mixed with air, particularly combustible substances likely to cause explosions, must not drive air motor.

- Do not drive with flammable or explosive gases or operate unit in an atmosphere containing them.
- Air motor is designed for air only. Do not allow corrosive gases or particulate material to enter motor. Water vapor, oil-based contaminants, or other liquids must be filtered out.
- Do not use a hammer or force coupling or drive pulley onto shaft when installing drive onto air motor. This causes end thrust that could damage air motor.
- Ambient temperature should not exceed 250°F.
- Beware of any exposed and/or movable parts. Proper guards should be in place to prevent personal and/or property damage.
- Solid or liquid material exiting unit can cause eye or skin damage. Keep away from air stream.
- Always disconnect air supply before servicing.
- Do not allow air motor to "run free" at high speeds with no loads. Excessive internal heat build-up, loss of internal clearances and rapid motor damage will result.
- Some models may exceed 85dB(A) sound level. Hearing protection should be worn when in close proximity to these models.

## General

- Single-phase TEFC models include cord, plug and switch.
- EP models must be wired in the field by the user.
- DC-Variable-Speed electric models have a controller mounted to the mixer and they are pre-wired.
- Air motors include exhaust muffler.

### FL(G) - Flange Mount Series

Flange mount mixers are ideal for agitation of un-sealed vessels and can be fastened to almost any flat surface above the tank.

## Receiving

Before removing any packing, visually inspect the exterior of the shipment for any sign of damage. Should there be any damage, bring it to the attention of the delivering UPS or truck line and note the same on the receiving ticket. Should there be damage you must place a claim with the truck line. They are the only ones who will pay for the damage done and you are the only one who can place that claim.

## Installation

Your new mixer requires some assembly. Ensure ALL set-screws and fasteners on the unit have been tightened completely before operating the equipment. The impeller(s) and impeller-shaft have to be fitted to the machine before it's operational.

### Mounting Flange - Air or Electric 56C Mount

Below is the mounting hole pattern for the flange, which is a standard 150# floor flange - cast iron.

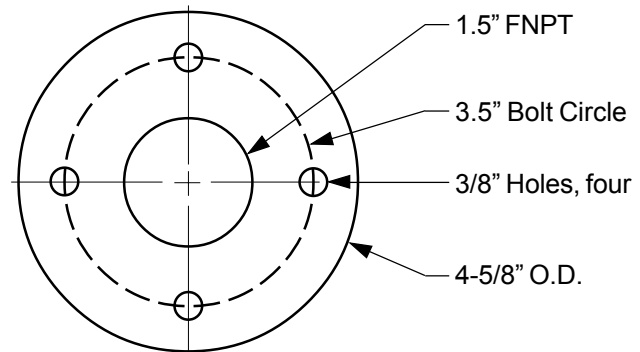

### Mounting Flange - Air Motor with Hub Mount

Below is the mounting hole pattern for the flange, which is cast aluminum.

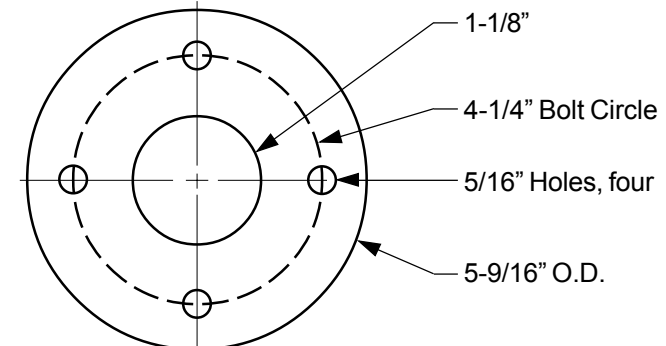

## Installation, continued

### Gear Drive, FLG Series

- The gear box is filled with oil.
- The brass plug supplied loose is a Filler-Vent Plug. After mounting the mixer, install the Filler-Vent Plug in the highest filler point as shown below.

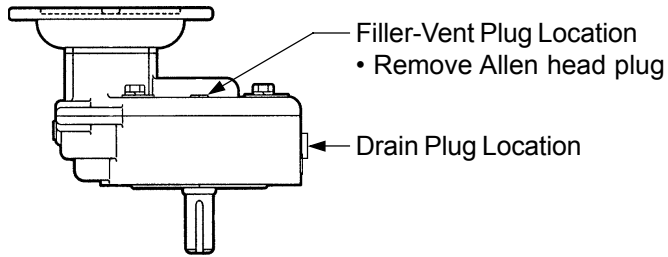

### Shaft & Coupler

To install mixer shaft, back off the set screws as far as possible without removing them. Insert mixing shaft into the coupler as far as it will go. Tighten ALL the set screws firmly to secure the shaft to the coupler.

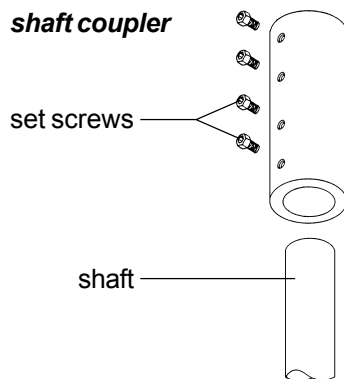

### Impellers

The standard impellers are 3-bladed marine style. To install the propeller, back off the set screw(s) as far as possible without removing them. Insert mixing shaft into the bore and tighten the set screw(s) firmly to secure the shaft to the propeller.

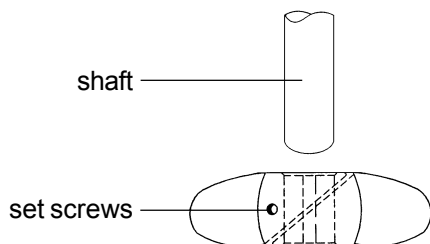

### Impeller Placement

For mixers with ONE impeller, mount it 1 to 2 impeller diameters distance off the bottom of mixing container. For mixers with TWO or more impellers, mount the lowest impeller 1 to 2 impeller diameters distance off the bottom of mixing container. Mount the other impellers 1 to 2 impeller diameters apart. The uppermost impeller should be positioned approximately 1 impeller diameter under the surface of the liquid.

The above guide-lines are "rules of thumb" and may not be the best for your situation. Experimenting with impeller placement may provide your best results.

## Operation

**Electric Power:** Once the electric motor has been wired, check rotation to be sure the mixer shaft is rotating in a clock-wise direction, looking downward into the container.

**Air Power:** Check to ensure the air valve is in the closed position, then connect air supply. Check rotation to be sure the mixer shaft is rotating in a clock-wise direction, looking downward into the container.

Once the mixer is in the container, it is now safe to operate.

### CAUTION:

- ✓ **Never run mixer without a propeller.**
- ✓ **Never run the propeller in open air.**
- ✓ **Never run propeller outside a container.**

## Maintenance

Maintaining your mixer is not difficult if you follow these guidelines:

- Keep the mixer clean.
- Check all set-screws and fasteners, tighten as needed.
- Check all wiring on a regular basis and repair as needed.
- Air motor powered units:
  - Keep air supply dry and oil in the lubricator.

### Lubrication:

#### Gear Drive Models:

The gear box contains oil from the factory.

The recommended replacement oil is:

- Gearbox models #RPQ1 and RPQ2:
  - Mobil Extra Hecla
  - Shell Oil Omala 680
  - Texaco Meropa 680
  - or equivalent to above
    - For 50°F to 125°F ambient.
    - RPQ1 Oil capacity is 11 ounces.
    - RPQ2 Oil capacity is 14 ounces.

## Parts List - Drive Motors

Item 100	Part No.	Description		
Air Motors	3/4 HP	MTR-3/4-HUB-AIR-CCW N-K202	Hub Mount - 3/4 HP (2AM-NCC-16) CCW rotation only Repair Kit* (2AM-NCC-16)	
		MTR-3/4-56C-AIR N-K510	56C Mount - 3/4 HP (2AM-NRV-90) bi-rotational Repair Kit* (2AM-NRV-90)	
		HDW-1/4-VALVE HDW-2502-SNB N-AL445 N-AC980	Needle valve, brass - 1/4" Pipe nipple, steel - 1/4" X 2" Muffler, plastic Muffler, metal	
	1.5 HP	MTR-1.5-HUB-AIR N-K205	Hub Mount - 1.5 HP (4AM-NRV-22B) bi-rotational Repair Kit* (4AM-NRV-22B)	
		MTR-1.5-56C-AIR N-K206A	56C Mount - 1.5 HP (4AM-NRV-50C) bi-rotational Repair Kit* (4AM-NRV-50C)	
		HDW-1/4-VALVE HDW-25-CNG N-AL445 N-AC980	Needle valve, brass - 1/4" Pipe nipple, steel - 1/4" X 7/8" Muffler, plastic Muffler, metal	
	4 HP	MTR-4-56C-AIR N-K208	56C Mount - 4 HP (6AM-NRV-11A) bi-rotational Repair Kit* (6AM-NRV-11A)	
		HDW-1/2-VALVE HDW-50-CNG N-AC990	Needle valve, brass - 1/2" Pipe nipple, steel - 1/2" X 1-1/8" Muffler, metal	
	* Repair Kits include: Vanes, shaft seal, o-rings, DE & NDE bearings, body & end cap gaskets.			
	Electric Motors	1/3 HP	MTR-1/3-56C-1-EP	56C, fixed speed 1/3 HP Explosion-Proof 115/230VAC 1-phase
			MTR-1/3-56C-1-TEFC CPG-INLINE-18/3	56C, fixed speed 1/3 HP TEFC 115/230VAC 1-phase Cord 18/3 - 6', plug and in-line ON-OFF switch
			MTR-098004 MTR-DC-CONTROL CPG-18/3 MET-VSO-BRACKET	56C, variable speed 1/3 HP TEFC 115VAC to 90VDC 1-phase DC motor controller, variable speed - 1/3 thru 2HP Cord 18/3 - 6' with plug Angle brackets, mounts v.s. controller to motor (2 req'd)

## Parts List - Drive Motors (continued)

Item 100	Part No.	Description					
<b>Electric Motors</b>	<b>1/2 HP</b>	MTR-1/2-56C-1-EP	56C, fixed speed	1/2 HP Explosion-Proof	115/230VAC	1-phase	
		MTR-1/2-56C-1-TEFC CPG-INLINE-18/3	56C, fixed speed Cord 18/3 - 6', plug and in-line ON-OFF switch	1/2 HP TEFC	115/230VAC	1-phase	
		MTR-098000 MTR-DC-CONTROL CPG-18/3 MET-VSO-BRACKET	56C, variable speed DC motor controller, variable speed - 1/3 thru 2HP Cord 18/3 - 6' with plug Angle brackets, mounts v.s. controller to motor (2 req'd)	1/2 HP TEFC	115VAC to 90VDC	1-phase	
		MTR-3/4-56C-1-EP	56C, fixed speed	3/4 HP Explosion-Proof	115/230VAC	1-phase	
	<b>3/4 HP</b>	MTR-3/4-56C-1-TEFC CPG-14/3 SWT-TOGGLE SWT-GUARD	56C, fixed speed Cord 14/3 - 5' with plug ON - OFF switch Switch guard	3/4 HP TEFC	115/230VAC	1-phase	
		MTR-108018 MTR-DC-CONTROL CPG-14/3 MET-VSO-BRACKET	56C, variable speed DC motor controller, variable speed - 1/3 thru 2HP Cord 14/3 - 5' with plug Angle brackets, mounts v.s. controller to motor (2 req'd)	3/4 HP TEFC	115VAC to 90VDC	1-phase	
		<b>1 HP</b>	MTR-1-56C-1-EP	56C, fixed speed	1 HP Explosion-Proof	115/230VAC	1-phase
			MTR-1-56C-1-TEFC CPG-14/3 SWT-DP-TOGGLE SWT-GUARD	56C, fixed speed Cord 14/3 - 5' with plug ON - OFF switch Switch guard	1 HP TEFC	115/230VAC	1-phase
	MTR-108022 MTR-DC-CONTROL CPG-14/3 MET-VSO-BRACKET		56C, variable speed DC motor controller, variable speed - 1/3 thru 2HP Cord 14/3 - 5' with plug Angle brackets, mounts v.s. controller to motor (2 req'd)	1 HP TEFC	115VAC to 90VDC	1-phase	

**Parts List: FL(G) Series**

Air Motor  
Hub Motor Mount  
- Direct Drive -

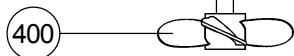
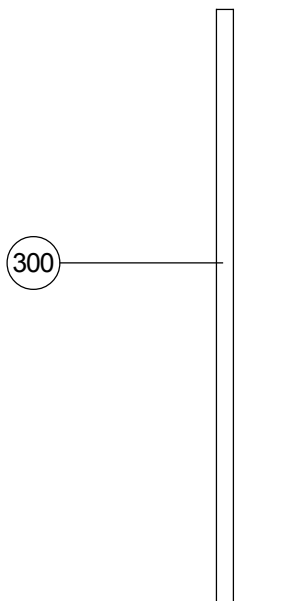
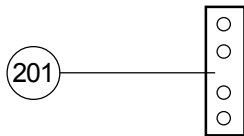
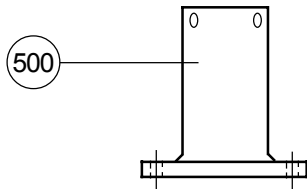
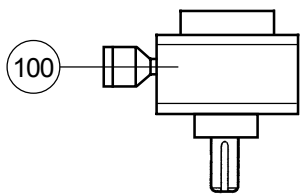

Air & Electric Motor  
56C Motor Flange  
- Direct Drive -

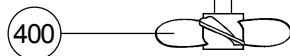
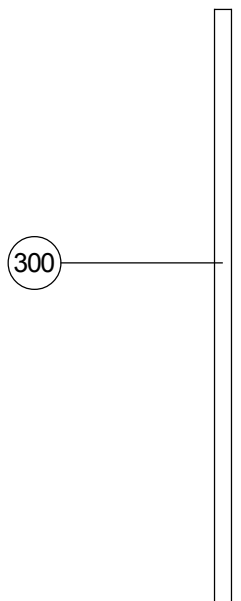
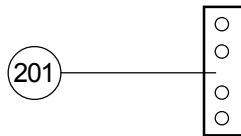
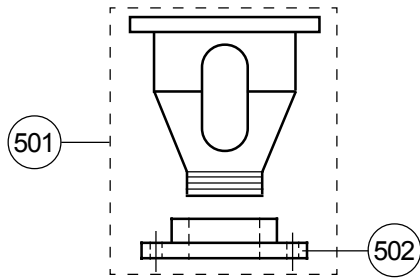
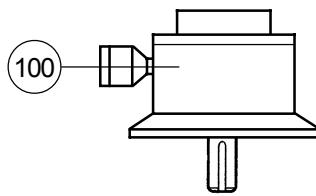
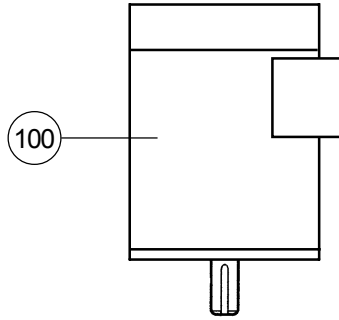

Air & Electric Motor  
56C Motor Flange  
- Gear Drive -

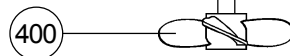
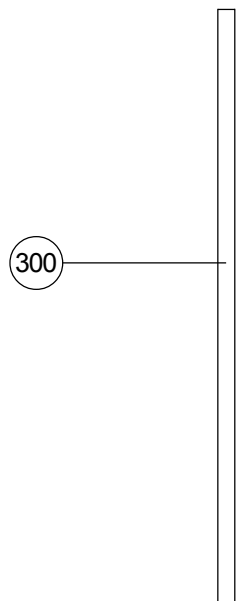
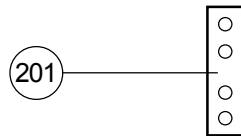
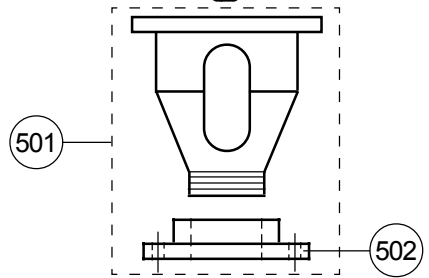
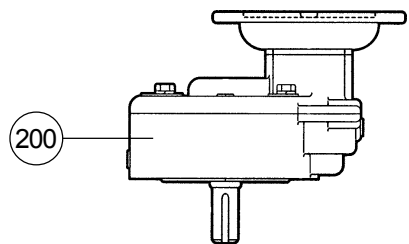
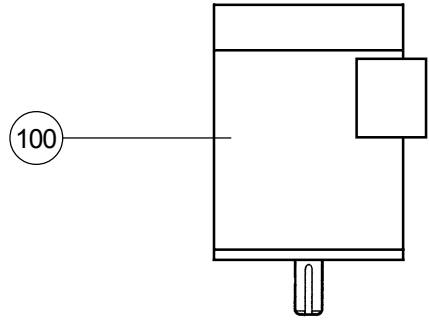

**Parts List:        FL(G) Series**

<b>Item</b>	<b>Description</b>	<b>Part No.</b>	<b>Qty.</b>
100.	Motor, air	see 'Parts List - Drive Motors'	1
100.	Motor, electric	see 'Parts List - Drive Motors'	1
200.	Gear Box, 5:1 ratio	HDW-GB-56C	1
200.	Gear Box, 5:1 ratio for: <b>FLG-4A</b> only	HDW-GB-56C-LG	1
201.	Coupling - shaft, 1/2" bore X 5/8" bore - stainless	CPL-5062	1
201.	Coupling - shaft, 5/8" bore X 5/8" bore - stainless	CPL-6262	1
201.	Coupling - shaft, 5/8" bore X 3/4" bore - stainless	CPL-6275	1
300.	Shaft - impeller, 5/8" dia. X 36" long - stainless	SS636	1
300.	Shaft - impeller, 3/4" dia. X 48" long - stainless	N-SHF-7548	1
400.	Impellers	specify model	1~2
401.	Set screw (not shown)	specify model	2~4

**Mounting Flange Assembly:**

500.	Hub Mount, air motors - cast aluminum	N-MNT-FLA	1
501.	56C Face Mount, Air & Electric motors - cast aluminum w/ floor flange	N-MNT-FLE	1
502.	Floor Flange, 1.5", 150# - cast iron	HDW-150-FLANGE	1