

# Bracket Mount Mixers

## OWNERSMANUAL

### Warranty

Our products are guaranteed against defective materials and workmanship, we will repair or replace such items as may prove defective at our option. Warranty period is one year on items manufactured by INDCO, except for the MixMaster Series Shakers which carries a two year warranty. On items not manufactured by INDCO, the manufactures warranty applies. All component parts of our products are covered by this warranty, except for normal wear items such as belts or impellers. We cannot be responsible for damage or abuse to equipment caused by improper installation or operation. Warranties can also be voided by unauthorized disassembly of equipment. For warranty repairs, equipment is returned to INDCO at the customer's expense; we will repair and return to customer at our expense. Under no circumstances will we allow labor charges or other expense to repair defective merchandise. This warranty is exclusive and is in lieu of all other warranties, whether express or implied. INDCO shall not be liable for any other damages, whether consequential, indirect, or incidental, arising from the sale or use of its products.



## BGTC/BTC Series Mixers

### TABLE OF CONTENTS:

Safety & General .....	2
Operation.....	3
Maintenance.....	4
Troubleshooting .....	5-9
Parts List .....	10-11

4040 EARNINGS WAY • NEW ALBANY, IN 47150 • P: 812-941-5954  
F: 812-944-9742 • INDCO.COM • INFO@INDCO.COM

## Safety:

Please follow the below safety precautions. If there are any questions, please call INDCO at 800-942-4383. Please read this complete manual before trying to operate your mixer. Failure to follow these instructions could result in serious bodily injury or death.

- Do not touch moving parts while mixer is operating.
- Do not wear loose-fitting clothes or jewelry around an operating mixer. Keep all hands, feet, clothes, neckties, necklaces and other objects clear of moving parts.
- Never move the unit without a suitable lifting device.
- Have a qualified individual bring power to the unit.
- Always ground the unit. Never use an extension cord.
- Never run the unit in open air.
- Never adjust the speed without the unit running.
- Always lockout the power when working on the unit.

### ELECTRIC MOTOR SAFETY:

Motors should be installed, protected and fused in accordance with latest issue of National Electrical Code, NEMA Standard Publication No. MG 2 and local codes. Frames and accessories of motors should be grounded in accordance with National Electrical Code (NEC) Article 430. For general information on grounding refer to NEC Article 250. Not all rotating parts are guarded. Keep hands and clothing away from moving parts. Trained, qualified personnel should make electrical repairs and non-standard connections. If environment has hazardous combustible fumes present, use only explosion-proof electric motors.

### AIR MOTOR SAFETY:

The air motor is designed to be driven by compressed air and under no circumstances be driven with any other gases. Fluids, particles, solids or any substance mixed with air, particularly combustible substances likely to cause explosions, must not drive air motor.

- Do not drive with flammable or explosive gases or operate unit in an atmosphere containing them.
- Air motor is designed for air only. Do not allow corrosive gases or particulate material to enter motor. Water vapor, oil-based contaminants, or other liquids must be filtered out.
- Do not use a hammer or force coupling or drive pulley onto shaft when installing drive onto air motor. This causes end thrust that could damage air motor.
- Ambient temperature should not exceed 250°F.
- Beware of any exposed and/or movable parts. Proper guards should be in place to prevent personal and/or property damage.
- Solid or liquid material exiting unit can cause eye or skin damage. Keep away from air stream.
- Always disconnect air supply before servicing.
- Do not allow air motor to “run free” at high speeds with no loads. Excessive internal heat build-up, loss of internal clearances and rapid motor damage will result.
- Some models may exceed 85dB(A) sound level.

### GENERAL:

INDCO bracket mount mixers are excellent for agitation of light to medium viscosity materials. The standard mounting bracket fits totes and other containers between 34” and 48” wide. These units are easily movable from one container to another.

- TEFC models are supplied with cord, plug and switch.
- EP models must be wired by the user.
- Variable Speed Electric models have a speed controller mounted on the mixer, pre-wired and power cord.

#### BT Series - DIRECT Drive

Standard electric models have output speed of 1750RPM. Variable speed electric motors run from 35 to 1750RPM and air models run from 300 to 3000RPM.

#### BGF Series - GEAR Drive

Standard electric models have output speed of 230RPM. Variable speed electric motors run from 0 to 230RPM and air models run from 40 to 400RPM.

## GENERAL (CONT.)

BTC-U Upgrade options

Ergonomic Toggle Clamp Bracket

BT and BGF series mixers can be upgraded to have an Ergonomic Toggle Clamp Bracket. The upgraded bracket can also accept a safety lift (BSL-D/BSL-G) and/or forklift channels (BLC-U).

## RECEIVING:

Before removing any packaging, visually inspect the exterior of the shipment for any sign of damage. Should there be any damage, bring it to the attention of the delivering UPS or truck line and note the same on the receiving ticket. Should there be damage you must place a claim with the truck line. They are the only ones who will pay for the damage done and you are the only one who can place that claim.

## INSTALLATION:

### Frame Bracket Assembly (standard)

Mounting bracket assembles to fit 34" to 48" wide Intermediate Bulk Containers (IBC) "totes" and other containers in this size range. Two hand-knobs tighten bracket assembly to size of container.

NOTE: Ensure ALL set-screws and fasteners on the unit have been tightened before operating the equipment.

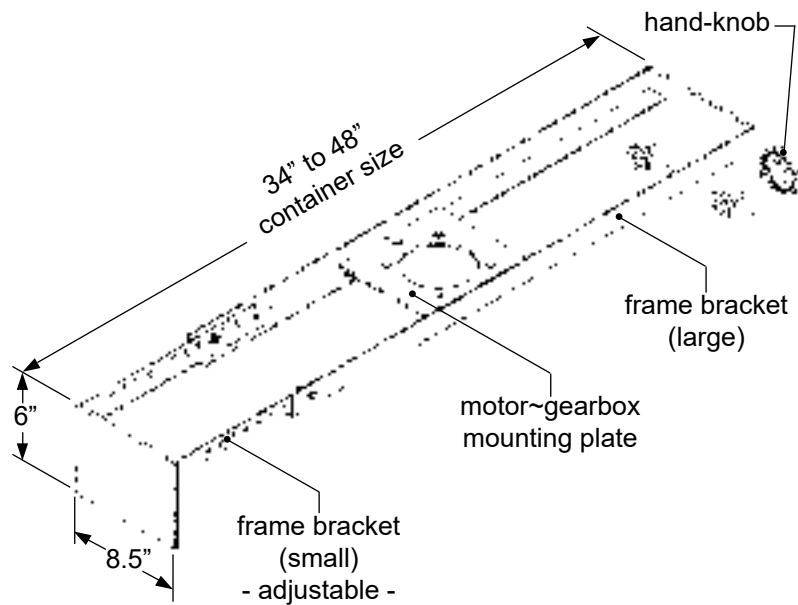

### Ergonomic Toggle Clamp

Two toggle-clamps pull mixer down and hold it to tote.

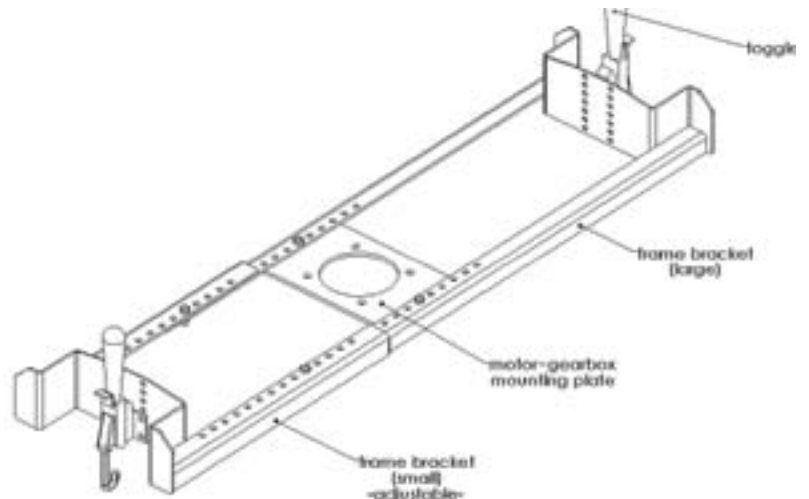

## Installation (cont)

### SAFETY LIFT (FOR ERGONOMIC TOGGLE CLAMP, DIRECT-DRIVE)

The BSL-D safety lift is for use with direct-drive mixers using the BTC-U bracket. The lift should be centered over the motor as shown.

### SAFETY LIFT (FOR ERGONOMIC TOGGLE CLAMP, GEAR DRIVE)

The BSL-G safety lift is for use with gear-drive mixers using the BTC-U bracket. The lift should be centered over the motor as shown.

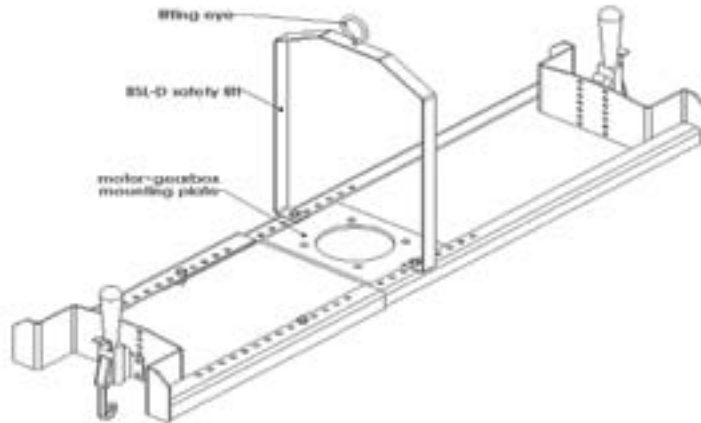

### IMPELLER PLACEMENT:

For mixers with ONE impeller, mount it 1 to 2 impeller diameters distance off the bottom of mixing container. For mixers with TWO or more impellers, mount the lowest impeller 1 to 2 diameters distance off the bottom of the mixing container. Mount the other impellers 1 to 2 impeller diameters apart. The uppermost impeller should be positioned approximately 1 impeller diameter under the surface of the liquid.

The above guide-lines are “rules of thumb” and may not be the best for your situation. Experimenting with impeller placement may provide your best results.

### Impellers - BT Series

The standard impellers are 3-bladed marine style. To install the propeller, back off the set screw(s) as far as possible without removing them. Insert mixing shaft into the bore and tighten the set screw(s) firmly to secure the shaft to the propeller.

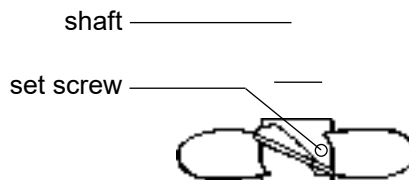

### Impellers - BGF Series

The standard impellers are Folding type. To install follow same procedure as BT Series, above.

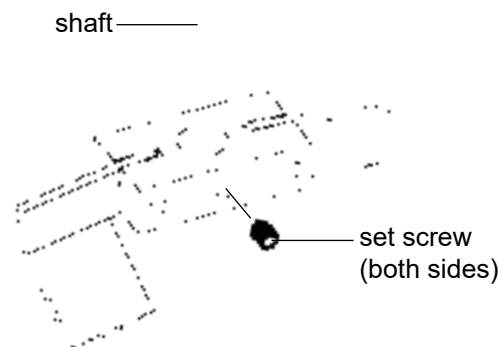

## Installation (cont)

### IMPELLER SHAFT - BGF SERIES

The impeller shaft mounts through the hollow gearbox shaft. Apply an “anti-seize” material in the hollow gearbox quill area. Tighten set-screws securely.

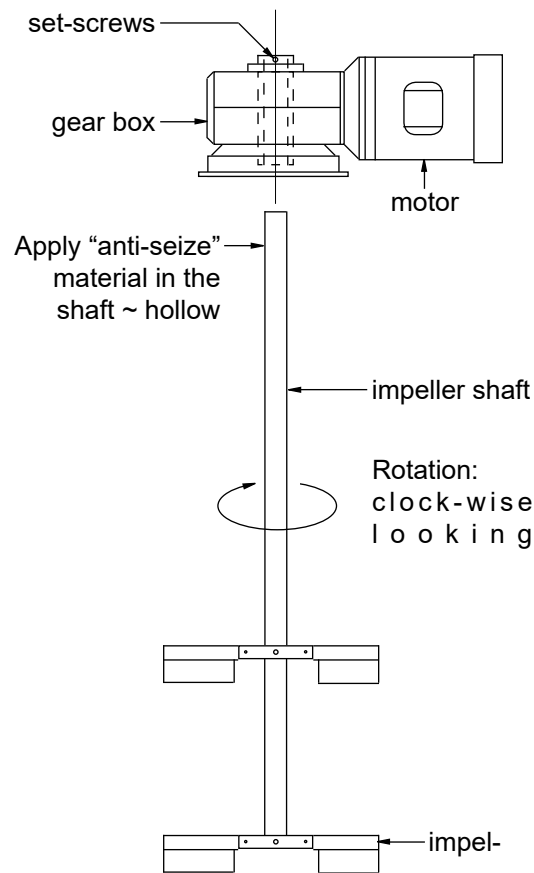

## Operation

### ELECTRIC POWER:

Once the electric motor has been wired, check rotation to be sure the mixer shaft is rotating in a clock-wise direction, looking downward into the container.

### AIR POWER:

Check to ensure the air valve is in the closed position, then connect air supply. Check rotation to be sure the mixer shaft is rotating in a clock-wise direction, looking downward into the container.

Once the mixer is in the container, it is now safe to operate. Always start and stop mixer in slowest speed.

### CAUTION:

- ü Never run mixer without a propeller.
- ü Never run propeller outside a container.

# Maintenance

Maintaining your mixer is not difficult if you follow these guidelines:

- Keep the mixer clean.
- Check all set-screws and fasteners, tighten as needed.
- Check all wiring on a regular basis and repair as needed.
- Air motor powered units:
  - Keep air supply dry and oil in the lubricator.

# Lubrication

BGF Series Models with Gear Reducers  
- Winsmith 917 & 920 Series

## **FACTORY FILLED:**

Your new speed reducer is filled to the proper level for standard mounting position with the appropriate grade of oil for operation in a 51°F to 110°F temperature environment. The oil level should be checked and adjusted (if necessary) prior to operation, using the oil plug provided and while the unit is oriented in its operating position.

If operating ambient temperature is outside the range specified above, then refer to the lubrication chart and refill the unit with the correct grade based on actual ambient temperatures.

## **OIL CHANGING:**

When changing oil for any reason, it should be remembered that oils of various types may not be compatible. Therefore, when changing to a different oil, it is recommended that the housing be completely drained and thoroughly flushed with a light flushing oil prior to refilling with the appropriate lubricant. The oil level should be rechecked after a short period of operation and adjusted if necessary.

## **INITIAL OIL CHANGE:**

The oil in a new speed reducer should be changed at the end of 250 hour of operation.

## **SUBSEQUENT OIL CHANGES:**

Under normal conditions, after the initial oil change, the oil should be changed after every 2,500 hours of operation, or every six months, whichever occurs first. Under severe conditions (rapid temperature changes, moist, dirty or corrosive environment) it may be necessary to change oil at intervals of one to three months. Periodic examination

## **SYNTHETIC OILS:**

Synthetic lubricants can be advantageous over mineral oils in that they generally are more stable, have longer life, and operate over a wider temperature range. These oils are appropriate for any application but are especially useful when units are subjected to low start-up temperatures or high operating temperatures. However, continuous operation above 225°F may cause damage to the seals or other components. It is recommended that the initial oil be changed or filtered after the first 1500 hours of operation to remove metal particles that accumulate during break-in. Subsequent oil changes should be made after 5000 hours operation if units are operating in a clean environment.

## **OIL TEMPERATURE:**

Speed reducers in normal operation can generate temperature up to 200°F depending on the type of reducer and the severity of the application (loading, duration of service, ambient temp.). Excessive temperature can result from overloading due to original unit selection being too small for the application or increased load after original load size was selected. Overfilling and Under filling the oil level of a speed reducer will cause overheating. Ensure oil is at the proper level.

**Lubricants:**

Below is just a few of the recommended lubricants that should be used in your speed reducer.

**LUBRICANTS:**

Below is just a few of the recommended lubricants that

Ambient Temp.	16 to 50°F	51 to 110°F	111 to 165°F
Max.Op.Temp.	185°F	200°F	200°F
ISO Visc.Grade	460	680	1000
AGMA Lub.No.	#7 Comp.	#8 Comp.	#8A Comp.
Mobil Oil	600W	600W Super	Extra Hecla
Shell Oil	Omala 460	Omala 680	Omala 800
Sun Oil	Sunep 1110	Sunep 1150	Oil 8 AC

**PARTS LIST - DRIVE MOTORS:**

Part No.	Description
<b>Air Motors</b> <b>3/4 HP</b>	MTR-3/4-56C-AIR Motor, air - 3/4 HP (2AM-NRV-90) - 56C face mount, bi-rotational
	HDW-1/4-VALVE Needle valve, brass - 1/4"
	HDW-2502-SNB Pipe nipple, steel - 1/4" x 2"
	N-AC980 Muffler, metal
	N-K510 Repair Kit
<b>Air Motors</b> <b>1.5 HP</b>	MTR-1.5-56C-AIR Motor, air - 1.5 HP (4AM-NRV-50C) - 56C face mount, bi-rotational
	HDW-1/4-VALVE Needle valve, brass - 1/4"
	HDW-25-CNG Pipe nipple, steel - 1/4" x close
	N-AC980 Muffler, metal
	N-K206A Repair Kit
<b>Air Motors</b> <b>4 HP</b>	MTR-4-56C-AIR Motor, air - 4 HP (6AM-NRV-11A) - 56C face mount, bi-rotational
	HDW-1/2-VALVE Needle valve, brass - 1/2"
	HDW-50-CNG Pipe nipple, steel - 1/2" x close
	N-AC990 Muffler, metal
	N-K208 Repair Kit
<b>Electric Motors</b> <b>1/2 HP</b>	MTR-1/2-56C-1-TEFC Motor, electric, fixed speed - 1/2 HP Explosion-Proof - 115/230VAC - single
	MTR-1/2-56C-1-TEFC Motor, electric, fixed speed - 1/2 HP TEFC - 115/230VAC - single phase
	CPG-INLINE-18/3 Cord 18/3 - 6', plug and in-line ON-OFF switch
	MTR-098000 Motor, electric, variable speed - 1/2 HP TEFC - 115VAC to 90VDC - single phase
	MTR-DC-CONTROL DC motor controller, variable speed - 1/3 thru 2HP
	CPG-18/3 Cord 18/3 - 6' with plug
	MET-VSO-BRACKET Angle brackets, mounts v.s. controller to motor (2 req'd)

**PARTS LIST - DRIVE MOTORS, CONTINUED:**

Part No.	Description
<b>3/4HP</b>	MTR-3/4-56C-1-EP Motor, electric, fixed speed - 3/4 HP Explosion-Proof - 115/230VAC - single phase
	MTR-3/4-56C-1-TEFC Motor, electric, fixed speed - 3/4 HP TEFC - 115/230VAC - single phase
	CPG-14/3 Cord 14/3 - 5' with plug
	SWT-TOGGLE ON - OFF switch
	SWT-GUARD Switch guard
	MTR-108018 Motor, electric, variable speed - 3/4 HP TEFC - 115VAC to 90VDC - single phase
	MTR-DC-CONTROL DC motor controller, variable speed - 1/3 thru 2HP
	CPG-14/3 Cord 14/3 - 5' with plug
	MET-VSO-BRACKET Angle brackets, mounts v.s. controller to motor (2 req'd)
	<b>1HP</b>
MTR-1-56C-1-TEFC Motor, electric, fixed speed - 1 HP TEFC - 115/230VAC - single phase	
CPG-14/3 Cord 14/3 - 5' with plug	
SWT-DP-TOGGLE ON - OFF switch	
SWT-GUARD Switch guard	
MTR-108022 Motor, electric, variable speed - 1 HP TEFC - 115VAC to 90VDC - single phase	
MTR-DC-CONTROL DC motor controller, variable speed - 1/3 thru 2HP	
CPG-14/3 Cord 14/3 - 5' with plug	
MET-VSO-BRACKET Angle brackets, mounts v.s. controller to motor (2 req'd)	
<b>1.5 HP</b>	
	MTR-1.5-56C-1-TEFC Motor, electric, fixed speed - 1.5 HP TEFC - 115/230VAC - single phase
	CPG-14/3 Cord 14/3 - 5' with plug
	SWT-DP-TOGGLE ON - OFF switch
	SWT-GUARD Switch guard
	MTR-108092 Motor, electric, variable speed - 1.5 HP TEFC - 230VAC to 180VDC - single phase
	MTR-DC-CONTROL DC motor controller, variable speed - 1/3 thru 2HP
	CRD-CORD Cord 12/3 - 4' no plug
	MET-VSO-BRACKET Angle brackets, mounts v.s. controller to motor (2 req'd)
	CPG-18/3 Cord 18/3 - 6' with plug
MET-VSO-BRACKET Angle brackets, mounts v.s. controller to motor (2 req'd)	



# Parts List - BT Series Mixer:

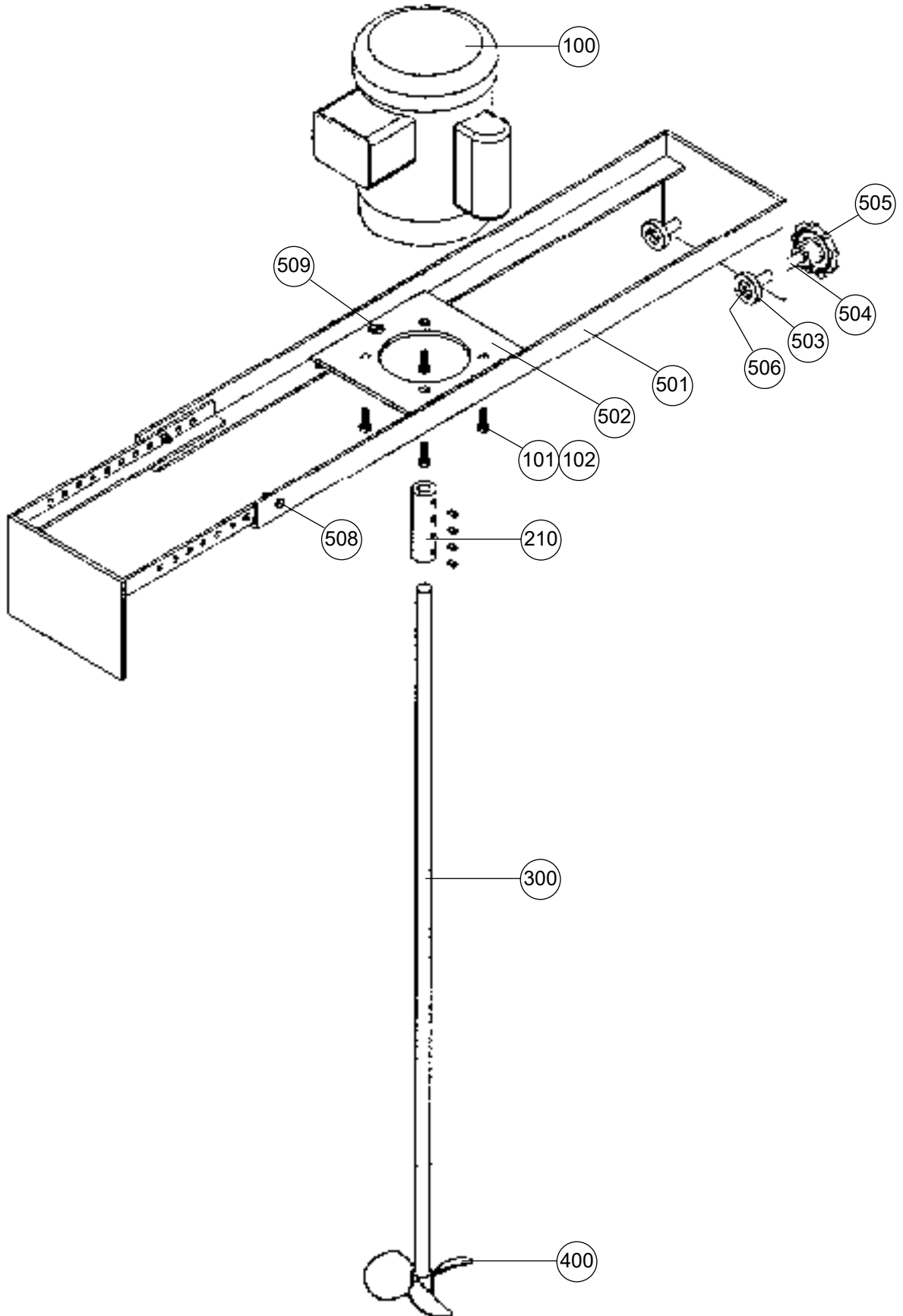

## Parts List - BT Series Mixer:

ITEM	DESCRIPTION	PART NO.	QTY.
100.	Motor, air	see 'Parts List - Drive Motors'	1
100.	Motor, electric	see 'Parts List - Drive Motors'	1
101.	Bolt, 3/8"-16 x 1"	N-HARDWARE	4
102.	Lock washer, 3/8"	N-HARDWARE	4
210.	Coupling - shaft, 5/8" bore x 3/4" bore	CPL-6275	1
300.	Shaft - impeller, 3/4" dia. x 32" long (stainless)	N-SHF-7532	1
300.	Shaft - impeller, 3/4" dia. x 36" long (stainless)	N-SHF-7536	1
300.	Shaft - impeller, 3/4" dia. x 40" long (stainless)	N-SHF-7540	1
400.	Impellers	specify model	1~2
401.	Set screw (not shown)	specify model	2~4
<b>BRACKET ASSEMBLY:</b>			
500.	Bracket Ass'y Complete, consisting of:	BT-403	1
501.	Adjustable bracket frame (set)	HDW-BD-02	1
502.	Motor mount plate - 8" x 8" with 56C hole pattern	HDW-BT403-MM	1
503.	Swivel pad	HDW-CSP-1	2
504.	Threaded rod, 1/2" x 4" long	SHF-TR124	2
505.	Hand knob, cast aluminum	HDW-HK42	2
506.	Drive screw pin, #14 x 3/4"	N-HARDWARE	2
507.	Spring pin, 3/16" x 1.25"	N-HARDWARE	2
508.	Bolt, 1/4"-20 x 1"	N-HARDWARE	2
508.	Lock washer, 1/4"	N-HARAWARE	2
508.	Nut, 1/4"-20	N-HARDWARE	2
509.	Bolt, 5/16"-18 x 1"	N-HARDWARE	2
509.	Lock washer, 5/16"	N-HARDWARE	2
509.	Nut, 5/16"-18	N-HARDWARE	2

# Parts List - BGF Series Mixer:

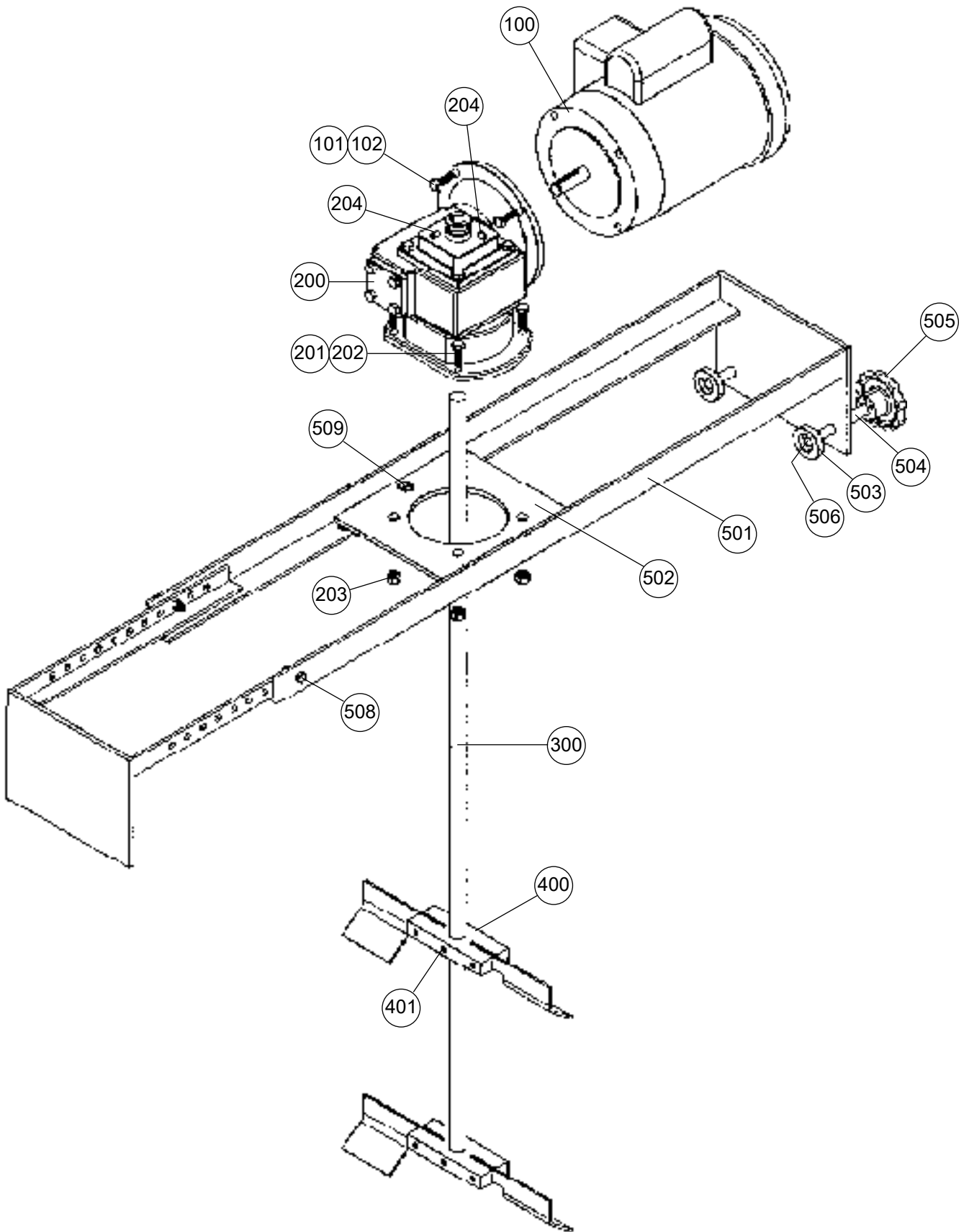

## Parts List - BGF Series Mixer:

ITEM	DESCRIPTION	PART NO.	QTY.
100.	Motor, air	see 'Parts List - Drive Motors'	1
100.	Motor, electric	see 'Parts List - Drive Motors'	1
101.	Bolt, 3/8"-16 x 1"	N-HARDWARE	4
102.	Lock washer, 3/8"	N-HARDWARE	4
200.	Gear Reducer, 7.5:1 ratio, All models except below.	HDW-GB-917.MDSF.DR	1
200.	Gear Reducer, 7.5:1 ratio, For BGF-400A only.	HDW-GB-920.MDSF.DR	1
201.	Bolt, 3/8"-16 x 1"	N-HARDWARE	4
202.	Lock washer, 3/8"	N-HARDWARE	4
203.	Nut, 3/8"	N-HARDWARE	4
204.	Set-screw, 1/4-20	N-HARDWARE	2
300.	Shaft - impeller, 3/4" dia. x 43" long (stainless)	N-SHF-3/4	1
400.	Impellers, folding - 10" diameter x 3/4" bore (stainless)	FP107	2
400.	Impellers, folding - 12" diameter x 3/4" bore (stainless)	FP127	2
400.	Impellers, folding - 14" diameter x 3/4" bore (stainless)	FP147	2
401.	Set screw, 1/4-20 (stainless)	N-HARDWARE	4
<b>BRACKET ASSEMBLY:</b>			
500.	Bracket Ass'y Complete, consisting of:	BT-403	1
501.	Adjustable bracket frame (set)	HDW-BD-02	1
502.	Motor mount plate - 8" x 8" with 56C mounting pattern	HDW-BT403-MM	1
503.	Swivel pad	HDW-CSP-1	2
504.	Threaded rod, 1/2" x 4" long	SHF-TR124	2
505.	Hand knob, cast aluminum	HDW-HK42	2
506.	Drive screw pin, #14 x 3/4"	N-HARDWARE	2
507.	Spring pin - hand knob, 3/16" x 1.25" (not shown)	N-HARDWARE	2
508.	Bolt, 1/4"-20 x 1"	N-HARDWARE	2
508.	Lock washer, 1/4"	N-HARDWARE	2
508.	Nut, 1/4"-20	N-HARDWARE	2
509.	Bolt, 5/16"-18 x 1"	N-HARDWARE	2
509.	Lock washer, 5/16"	N-HARDWARE	2
509.	Nut, 5/16"-18	N-HARDWARE	2

## Bracket mount – Toggle Clamp Adjustment

1. Locate gray mixer in two pieces on tote, note that the clamp may already be secured to the bracket (fig. A).

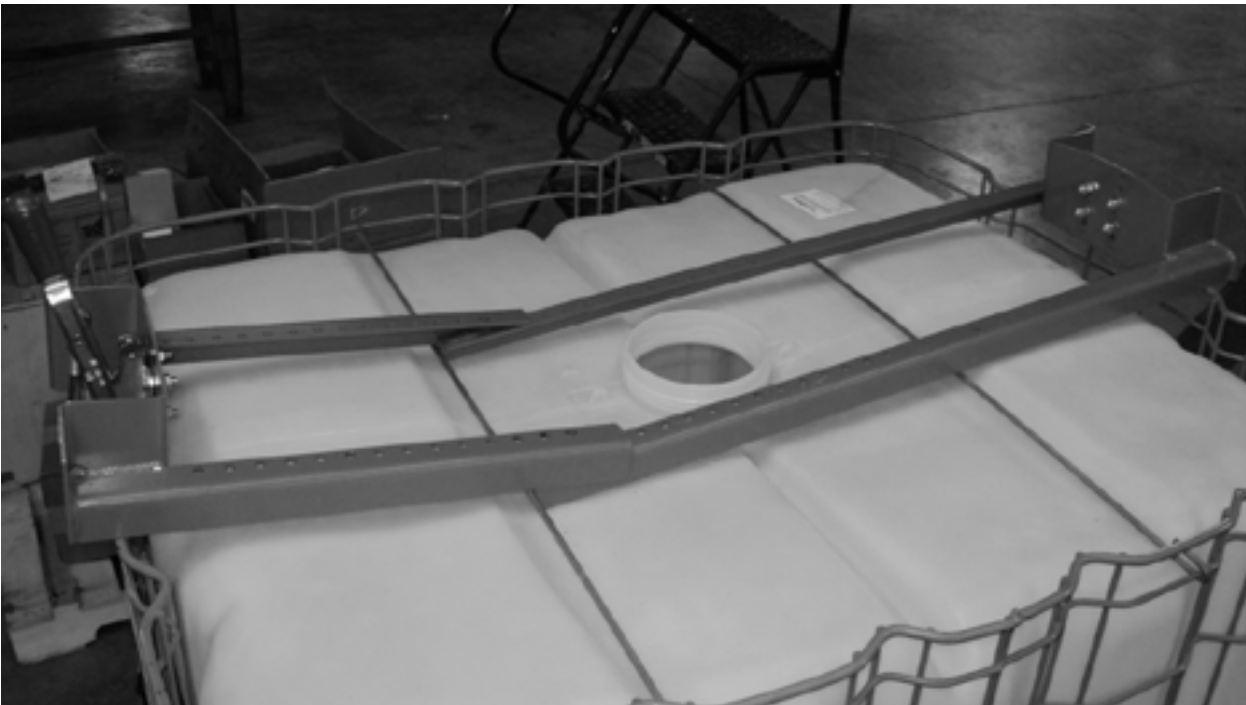

Fig A

2. Adjust height of clamp such that the lower J Hook connects with wire frame as shown.
3. Clamp should be located so that the handle is vertical.
4. Use bolts to secure clamp (fig B).



Fig B-1

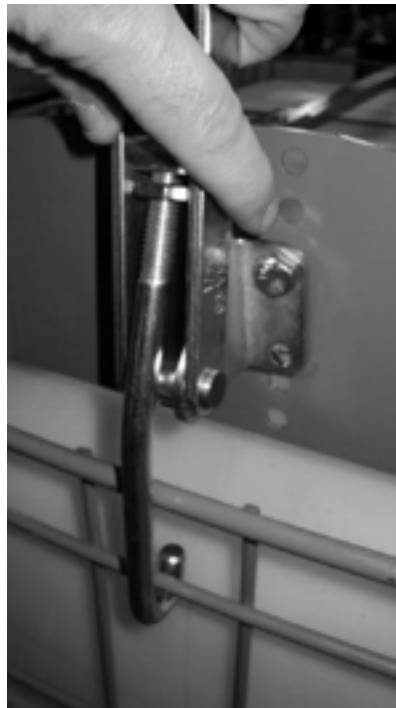

Fig B-2

5. Verify 1/8" minimum gap between the J-Hook and the upper wire frame as shown in Fig-C. This will ensure secure clamping on cage with toggle handle in vertical position.

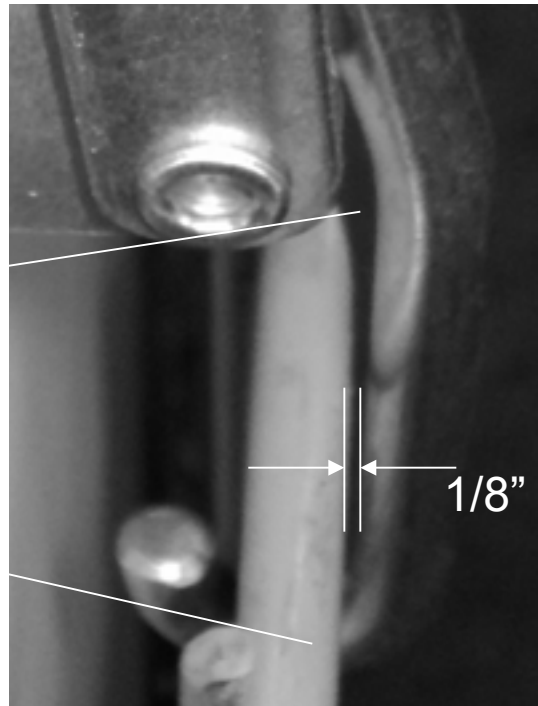
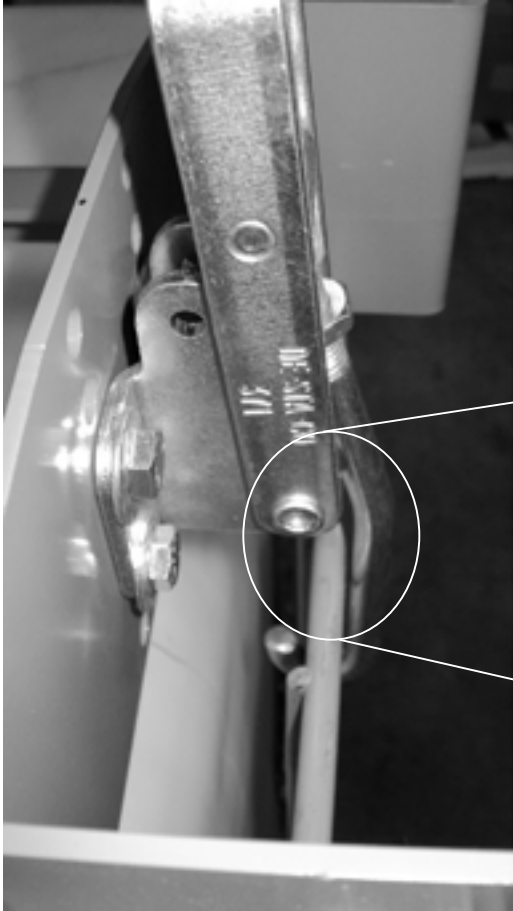
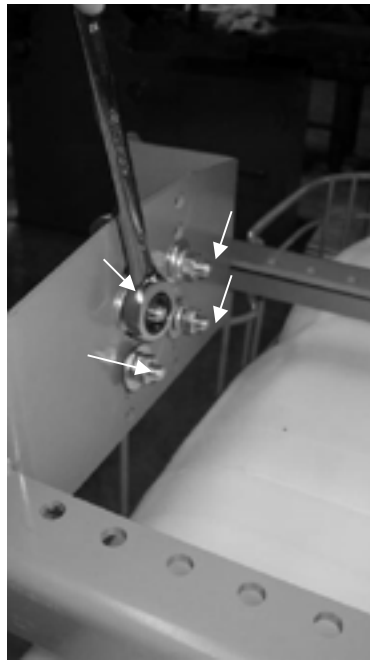
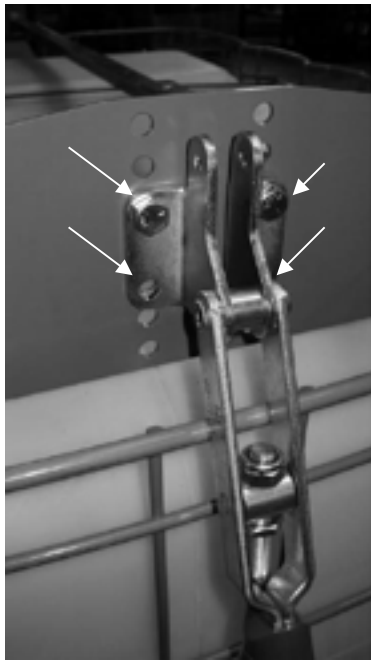
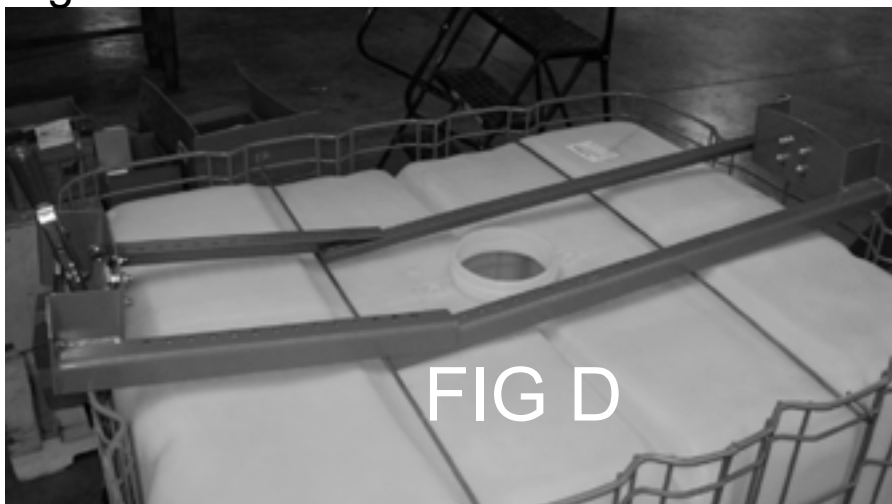

Fig C

6. Release clamp and install remaining hardware.



7. Install 2<sup>nd</sup> piece of the bracket mount, follow instructions 1~6 to locate and secure. Note that the center of the bracket mount has not yet been fastened and should look similar to the picture in figureD.





8. Secure the two halves together with the included hardware as shown. Note that the hardware should be located utilizing the slotted portion of the bracket

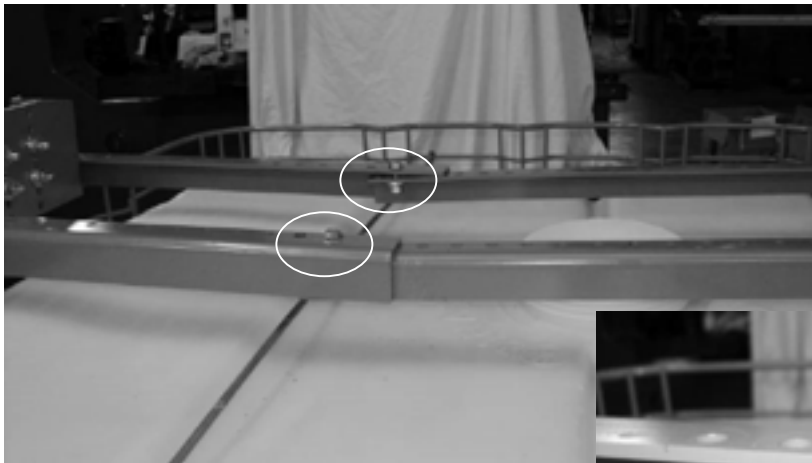

Locate then tighten.

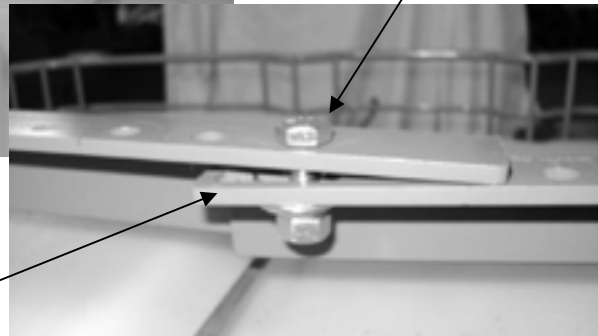

Slotted portion of bracket

9. Final adjustment: Latch clamp into position to check for final fit. Adjust clamp tension by tightening nut, then rotating clamp into position until desired tension is obtained.

Please note that there must be a minimum of an 1/8" gap between the J hook and the tote wire frame as shown in order to secure properly

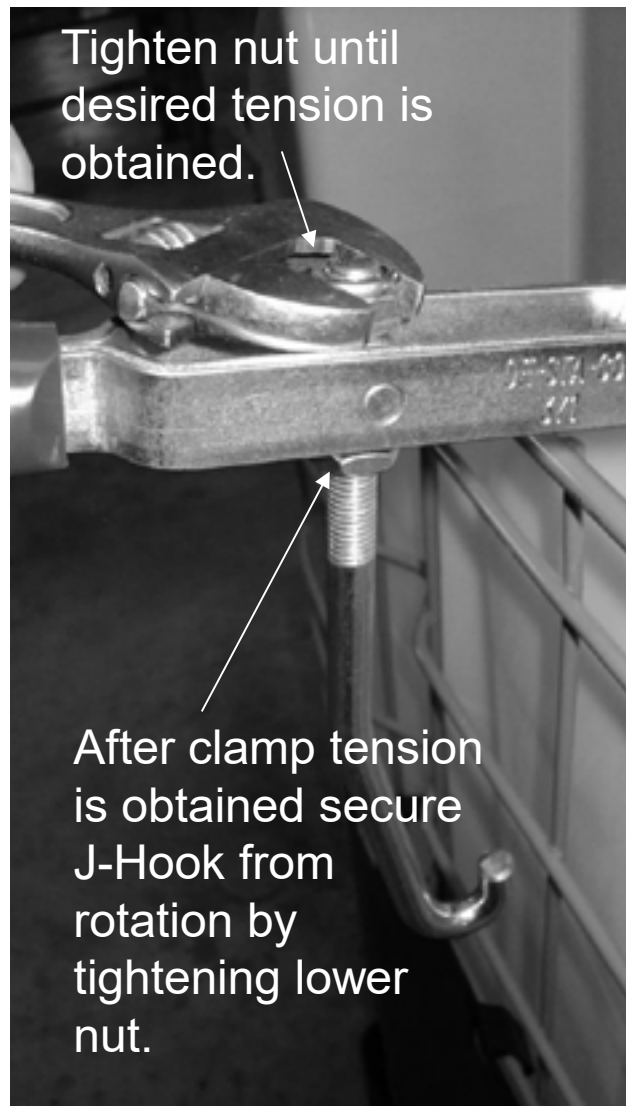

10. Cage style as shown below please follow the instructions for latch adjustment.



11. Adjust frame so that it is approximately 1/2" to 2" from the IBC tote cage as shown. 1-

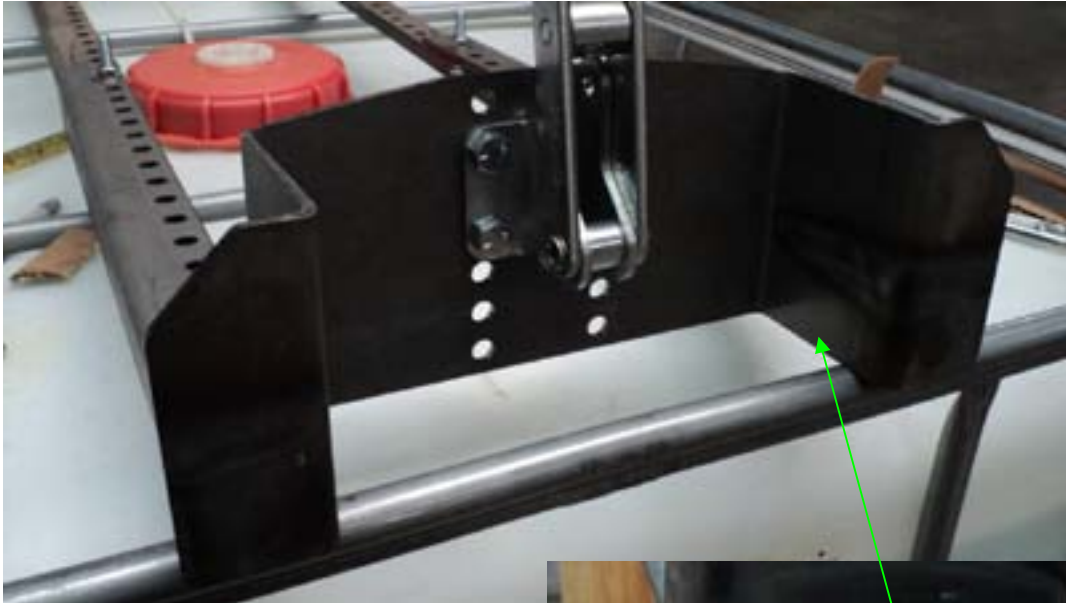

12. Adjust bracket to set of mounting holes as shown.



13. After frame and bracket have been located the J hook then needs to be adjusted. Remove the nut on the under side of the J-Hook (as shown).

Nylock nut should be installed but not tight.

Remove this nut.

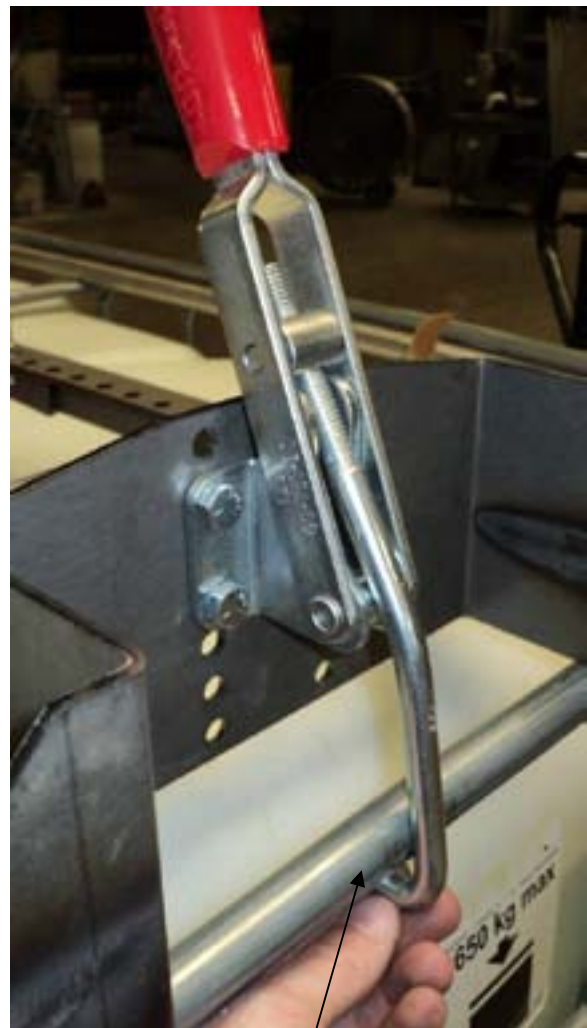
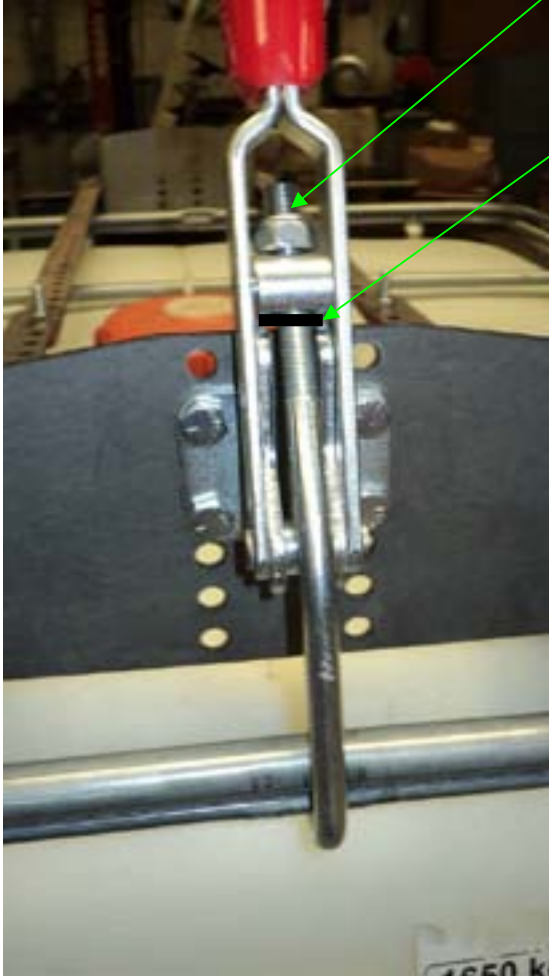

14. Rotate latch in the up position as shown. At the same time loosen the top nylock nut so that the latch will fit snug with the tote rail.

Tote rail

15. Slowly begin to tighten the top nylock nut. As you begin to tighten this nut release and engage the latch to check the tension. Adjust the tension as desired to secure the latch to the tote frame.

